

Weber's Electrodynamics

A. K. T. Assis

University of Campinas – Brazil

www.ifi.unicamp.br/~assis

Maxwell's equations (1861-1873):

Gauss's law:

$$\nabla \cdot \vec{E} = \frac{\rho}{\epsilon}$$

There are no magnetic monopoles:

$$\nabla \cdot \vec{B} = 0$$

Faraday's law:

$$\nabla \times \vec{E} = -\frac{\partial \vec{B}}{\partial t}$$

“Ampère's” circuital law with displacement current:

$$\nabla \times \vec{B} = \mu \vec{J} + \frac{1}{c^2} \frac{\partial \vec{E}}{\partial t}$$

“Lorentz's” force (1895):

$$\vec{F} = q\vec{E} + q\vec{v} \times \vec{B}$$

Wilhelm Weber (1804 – 1891)

J. C. Maxwell (1831 – 1879)



Professor of physics at Göttingen University
working in collaboration with Gauss

Coulomb (1785):
$$\vec{F} = \frac{q_1 q_2}{4\pi\epsilon_0} \frac{\hat{r}}{r^2}$$

Ampère (1822):
$$\vec{F} = -\frac{\mu_0}{4\pi} I_1 I_2 \frac{\hat{r}}{r^2} f(\alpha, \beta, \gamma)$$

Faraday (1831):
$$emf = -M \frac{dI}{dt}$$

Coulomb (1785):
$$\vec{F} = \frac{q_1 q_2}{4\pi\epsilon_0} \frac{\hat{r}}{r^2}$$

Ampère (1822):
$$\vec{F} = -\frac{\mu_0}{4\pi} I_1 I_2 \frac{\hat{r}}{r^2} f(\alpha, \beta, \gamma)$$

Faraday (1831):
$$emf = -M \frac{dI}{dt}$$

Weber's hypothesis:
$$I d\vec{\ell} \Leftrightarrow q\vec{v}$$

Weber's force:
$$\vec{F} = \frac{q_1 q_2}{4\pi\epsilon_0} \frac{\hat{r}}{r^2} \left[1 + K_1 v_1 v_2 + K_2 (a_1 - a_2) \right]$$

Weber's force (1846):

$$\vec{F} = \frac{q_1 q_2}{4\pi\epsilon_0} \frac{\hat{r}}{r^2} \left(1 - \frac{\dot{r}^2}{2c^2} + \frac{r \ddot{r}}{c^2} \right)$$

$$\dot{r} = \frac{dr}{dt}, \quad \ddot{r} = \frac{d^2 r}{dt^2}, \quad c = \frac{1}{\sqrt{\mu_0 \epsilon_0}}$$

Weber measured c in 1856: $c = 3 \times 10^8$ m/s.

Therefore, connection between electromagnetism and optics before Maxwell!

Properties of Weber's force

- In the static case ($dr/dt = 0$ and $d^2r/dt^2 = 0$) we return to the laws of Coulomb and Gauss.
- Action and reaction: Conservation of linear momentum.
- Force along the straight line connecting the particles: Conservation of angular momentum.
- It can be deduced from a velocity dependent potential energy:

$$U = \frac{q_1 q_2}{4\pi\epsilon_0} \frac{1}{r} \left(1 - \frac{\dot{r}^2}{2c^2} \right)$$

- Conservation of energy:
$$\frac{d(K + U)}{dt} = 0$$

- Faraday's law of induction can be deduced from Weber's force (see Maxwell, *Treatise*, Vol. 2, Chap. 23).
- "Ampère's" circuital law can also be deduced from Weber's force.

- Faraday's law of induction can be deduced from Weber's force (see Maxwell, *Treatise*, Vol. 2, Chap. 23).
- "Ampère's" circuital law can also be deduced from Weber's force.
- Weber's force is completely **relational**. It depends only on r , dr/dt and d^2r/dt^2 . It has the same value for all observers and in all systems of reference. It depends only on magnitudes intrinsic to the system of interacting charges. It depends only on the relation between the bodies.

Weber's Electrodynamics

by

André Koch Torres Assis

Kluwer Academic Publishers

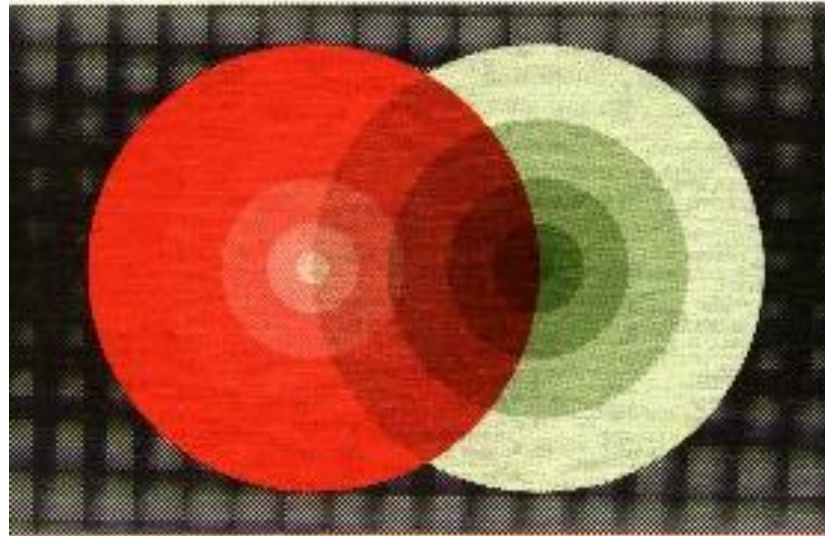

Fundamental Theories of Physics

1994
Kluwer
(Springer)

Weber → Ampère's force (1822-1826):

$$\vec{F} = -\frac{\mu_0}{4\pi} \frac{I_1 I_2}{r^2} \left[2(\vec{d\ell}_1 \cdot \vec{d\ell}_2) \hat{r} - 3(\hat{r} \cdot \vec{d\ell}_1)(\hat{r} \cdot \vec{d\ell}_2) \hat{r} \right]$$

Lorentz → Biot-Savart and Grassmann's force (1845):

$$\begin{aligned} \vec{F} &= I d\vec{\ell}_1 \times d\vec{B}_2 = I_1 d\vec{\ell}_1 \times \left(\frac{\mu_0}{4\pi} \frac{I_2 d\vec{\ell}_2 \times \hat{r}}{r^2} \right) \\ &= -\frac{\mu_0}{4\pi} \frac{I_1 I_2}{r^2} \left[(\vec{d\ell}_1 \cdot \vec{d\ell}_2) \hat{r} - (\vec{d\ell}_1 \cdot \hat{r}) d\vec{\ell}_2 \right] \end{aligned}$$

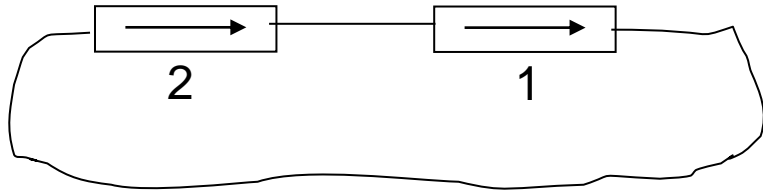
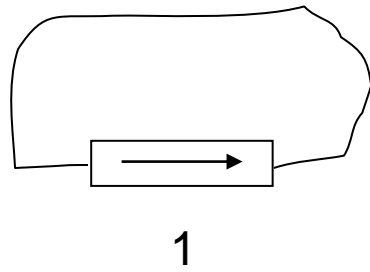
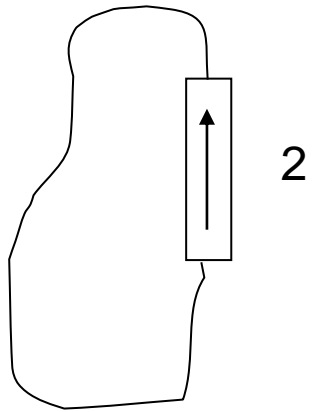

| | $F_{2 \text{ in } 1}$ | $F_{1 \text{ in } 2}$ |
|---|-----------------------|-----------------------|
| A | 0 | 0 |
| G | ↑ | 0 |

| | $F_{2 \text{ in } 1}$ | $F_{1 \text{ in } 2}$ |
|---|-----------------------|-----------------------|
| A | → | ← |
| G | 0 | 0 |

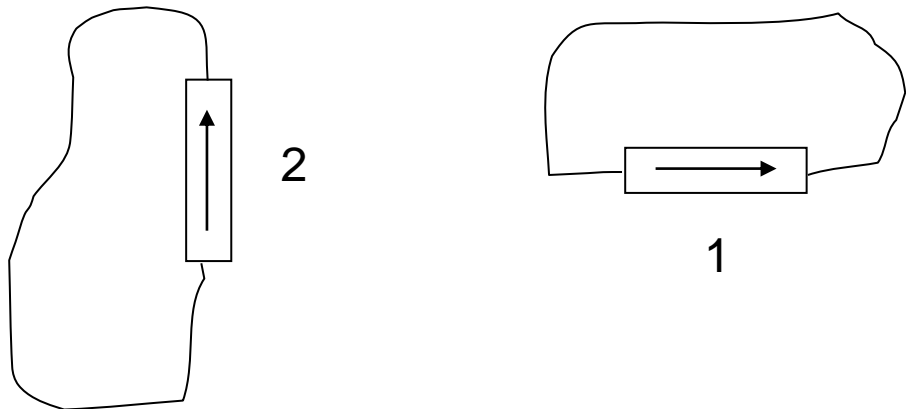

| | $F_{2 \text{ in } 1}$ | $F_{1 \text{ in } 2}$ |
|---|-----------------------|-----------------------|
| A | 0 | 0 |
| G | ↑ | 0 |

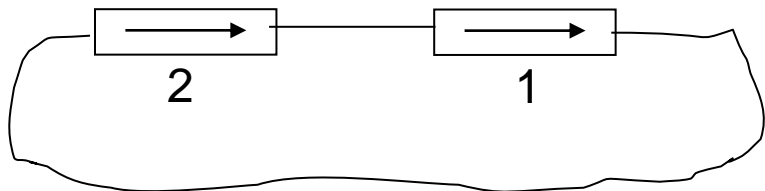

| | $F_{2 \text{ in } 1}$ | $F_{1 \text{ in } 2}$ |
|---|-----------------------|-----------------------|
| A | → | ← |
| G | 0 | 0 |

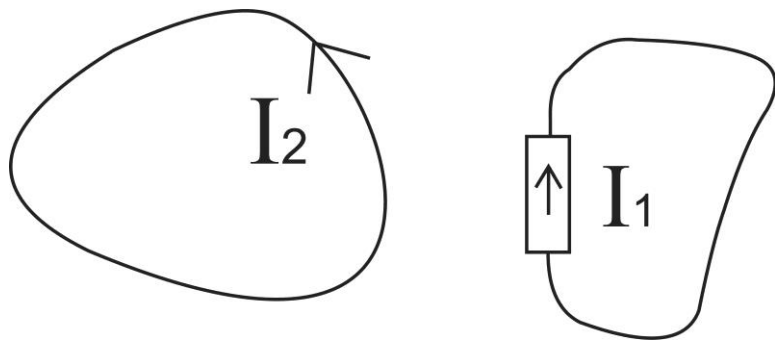

$$F_{2 \text{ in } 1}^A = F_{2 \text{ in } 1}^G =$$

$$I_1 d\vec{\ell}_1 \times \left(\frac{\mu_0}{4\pi} \oint \frac{I_2 d\vec{\ell}_2 \times \hat{r}}{r^2} \right)$$

Ampère X Grassmann:

Ampère's bridge:

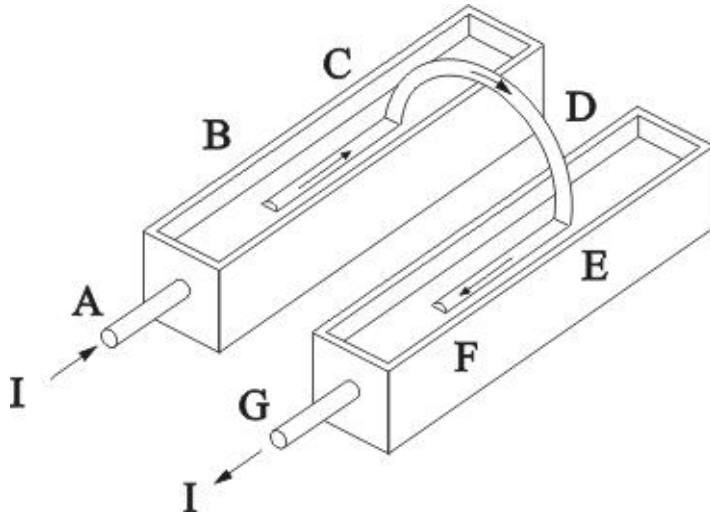

Electromagnetic impulse pendulum:

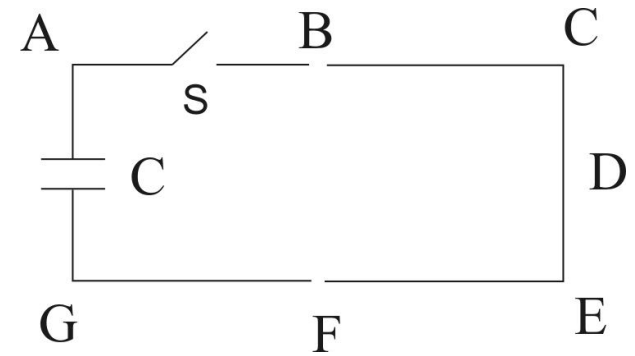

Exploding wire:

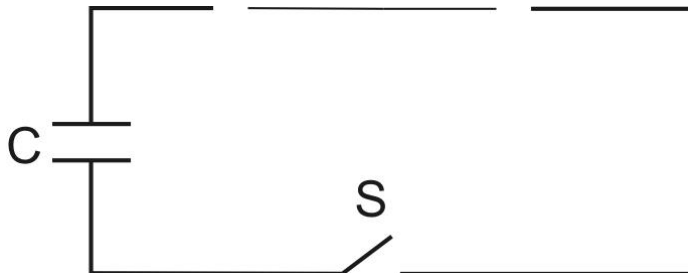

Maxwell (1873) in the *Treatise on Electricity and Magnetism* when comparing the forces between current elements of Ampère (1826), Grassmann (1845) and two other expressions created by Maxwell:

Article 527: “Of these four different assumptions that of Ampère is undoubtedly the best, since it is the only one which makes the forces on the two elements not only equal and opposite but in the straight line which joins them.”

Maxwell (1873) in the *Treatise on Electricity and Magnetism* when comparing the forces between current elements of Ampère (1826), Grassmann (1845) and two other expressions created by Maxwell:

Article 527: “Of these four different assumptions that of Ampère is undoubtedly the best, since it is the only one which makes the forces on the two elements not only equal and opposite but in the straight line which joins them.”

Maxwell's general assessment of Ampère's work:

Article 528: “The experimental investigation by which Ampère established the laws of the mechanical action between electric currents is one of the most brilliant achievements in science. The whole, theory and experiment, seems as if it had leaped, full grown and full armed, from the brain of the ‘Newton of electricity.’ It is perfect in form, and unassailable in accuracy, and it is summed up in a formula from which all the phenomena may be deduced, and which must always remain the cardinal formula of electrodynamics.”

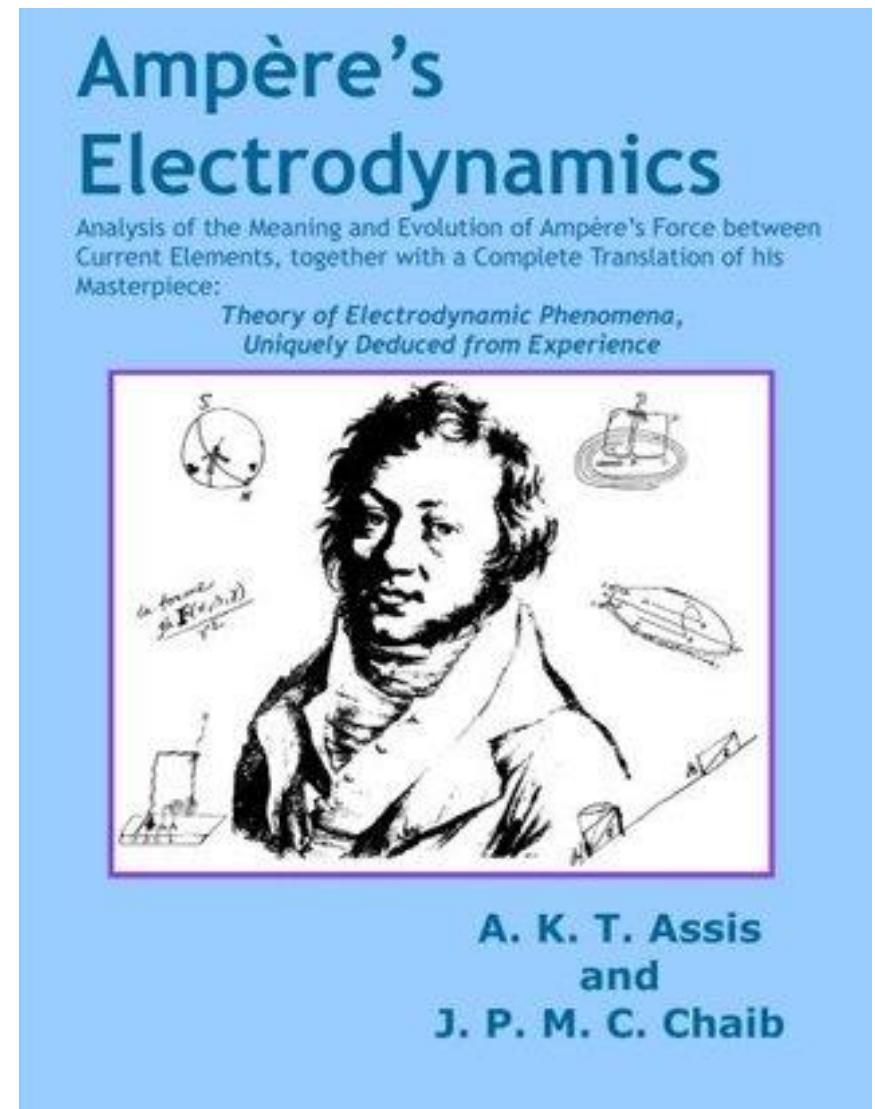
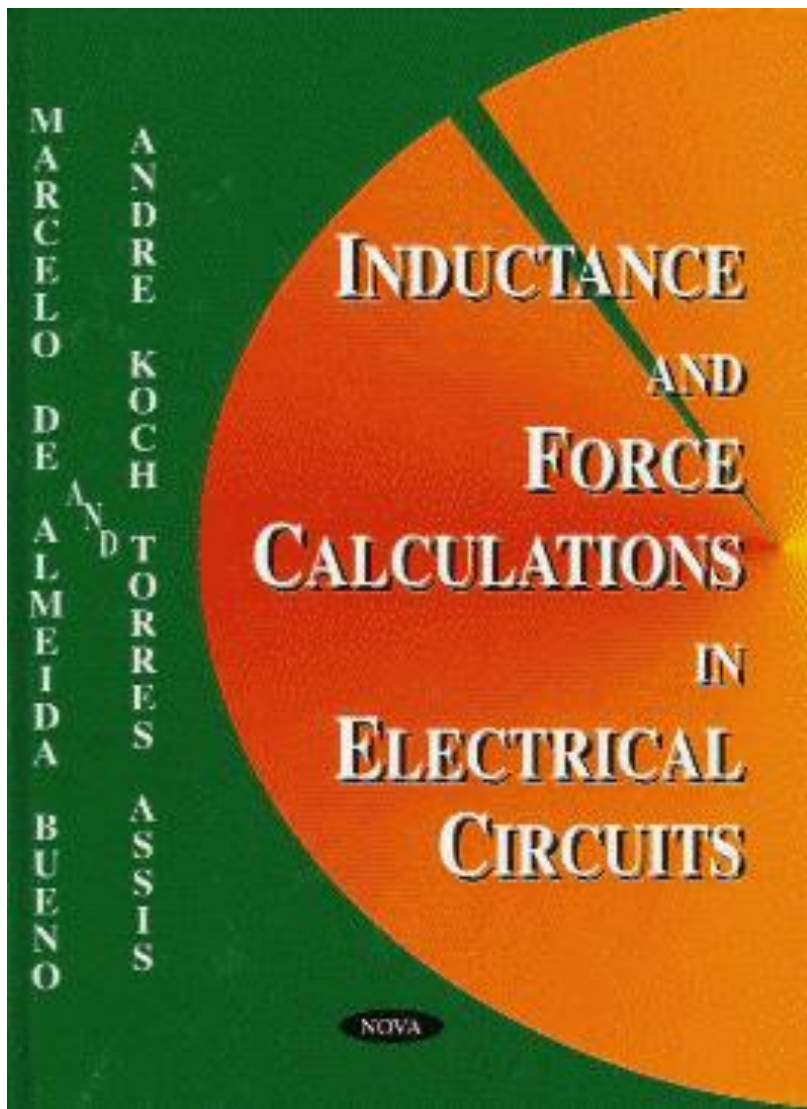

Available at www.ifi.unicamp.br/~assis

The propagation of electromagnetic signals was first obtained by Weber and Kirchhoff in 1857 utilizing Weber's electrodynamics, before Maxwell. In particular, they obtained the telegraph equation:

$$\vec{J} = g\vec{E} = -g\left(\nabla\phi + \frac{\partial\vec{A}}{\partial t}\right)$$

$$\nabla \cdot \vec{J} = -\frac{\partial\rho}{\partial t}$$

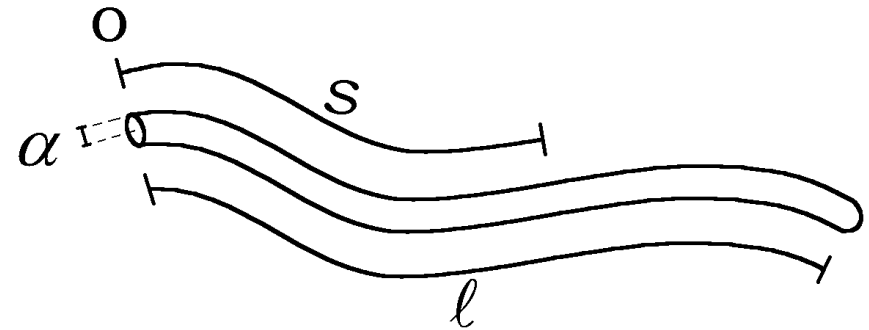

The propagation of electromagnetic signals was first obtained by Weber and Kirchhoff in 1857 utilizing Weber's electrodynamics, before Maxwell. In particular, they obtained the telegraph equation:

$$\vec{J} = g\vec{E} = -g\left(\nabla\phi + \frac{\partial\vec{A}}{\partial t}\right)$$

$$\nabla \cdot \vec{J} = -\frac{\partial\rho}{\partial t}$$

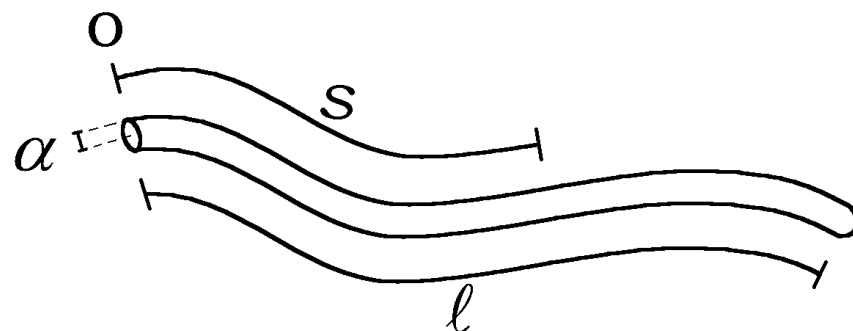

$$\frac{\partial^2 \xi}{\partial s^2} - \frac{1}{c^2} \frac{\partial^2 \xi}{\partial t^2} = \frac{2\pi\epsilon_0 R}{\ell \ln \frac{\ell}{\alpha}} \frac{\partial \xi}{\partial t}$$

with $\xi = I, \sigma, \phi, A$

Maxwell introduced the displacement current in “Ampère’s” circuital law in 1864-1873:

$$\nabla \times \vec{B} = \mu \vec{J} + \frac{1}{c^2} \frac{\partial \vec{E}}{\partial t}$$

Maxwell introduced the displacement current in “Ampère’s” circuital law in 1864-1873:

$$\nabla \times \vec{B} = \mu \vec{J} + \frac{1}{c^2} \frac{\partial \vec{E}}{\partial t}$$

However:

$$c = \frac{1}{\sqrt{\mu_0 \epsilon_0}}$$

Maxwell utilized the constant c which had been introduced by Weber in 1846.

$$c = 3 \times 10^8 \frac{m}{s}$$

Maxwell knew the value of this constant which had been first measured by Weber in 1856.

$$\frac{\partial^2 \xi}{\partial s^2} - \frac{1}{c^2} \frac{\partial^2 \xi}{\partial t^2} = 0$$

Maxwell knew that Weber and Kirchhoff, utilizing Weber’s force, had obtained the wave equation in 1857.

Main difference between the forces of Weber and Lorentz:

Weber's force depends on the position, velocity and acceleration \mathbf{a}_1 of the test body 1, that is, $F(r_1, r_2, v_1, v_2, \mathbf{a}_1, \mathbf{a}_2)$:

$$\vec{F} = \frac{q_1 q_2}{4\pi\epsilon_0} \frac{\hat{r}}{r^2} \left(1 - \frac{\dot{r}^2}{2c^2} + \frac{r \ddot{r}}{c^2} \right)$$

Lorentz's force depends only on the position and velocity of the test body, but **does not depend on its acceleration \mathbf{a}_1** , that is, $F(r_1, r_2, v_1, v_2, \mathbf{a}_2)$:

$$\vec{F}_{2 \text{ em } 1}^{\text{Lorentz}} = q_1 \vec{E} + q_1 \vec{v}_1 \times \vec{B}$$

Force exerted by a charged spherical shell acting on an internal test charge accelerated relative to the shell:

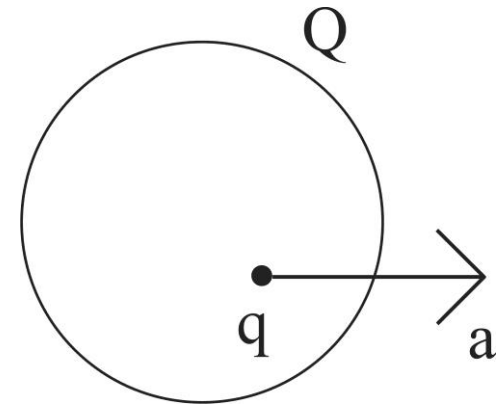

$$\vec{F}^{Lorentz} = 0$$

$$\vec{F}^{Weber} = \frac{\mu_0 q Q}{12\pi R} \vec{a}$$

According to Weber's electrodynamics, the test charge should behave as if it had an effective inertial mass which depends on the surrounding charges.

Force exerted by a spinning charged spherical shell acting on an internal test charge moving relative to the shell:

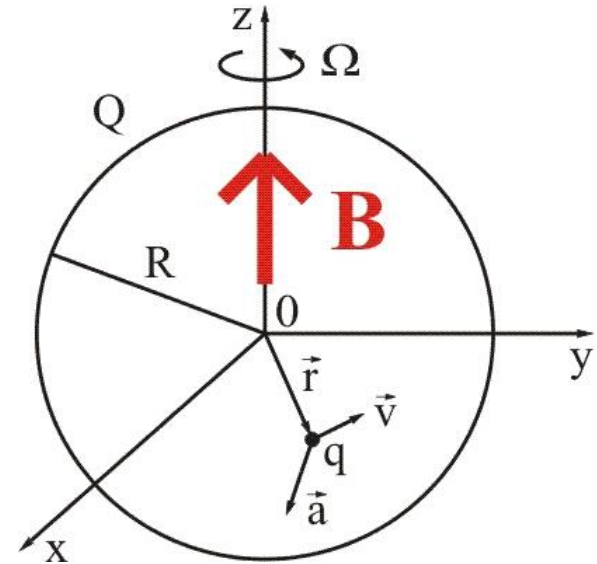

$$\vec{F}^{Lorentz} = q\vec{E} + q\vec{v} \times \vec{B} = q\vec{v} \times \frac{\mu_0 Q \vec{\Omega}}{6\pi R}$$

Force exerted by a spinning charged spherical shell acting on an internal test charge moving relative to the shell:

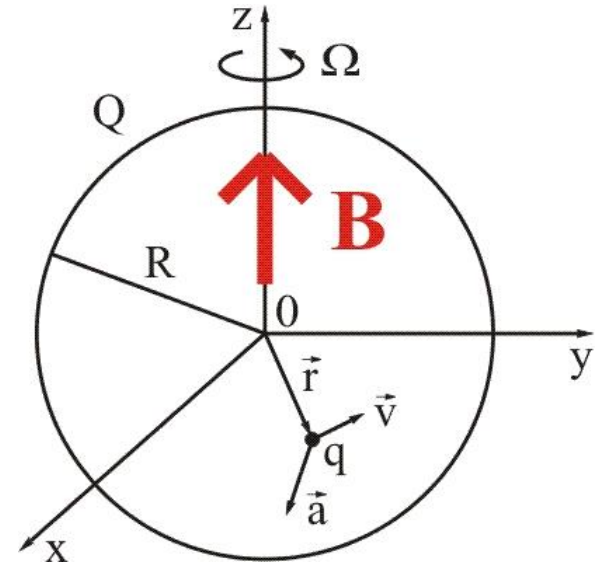

$$\vec{F}^{Lorentz} = q\vec{E} + q\vec{v} \times \vec{B} = q\vec{v} \times \frac{\mu_0 Q \vec{\Omega}}{6\pi R}$$

$$\vec{F}^{Weber} = \frac{\mu_0 q Q}{12\pi R} \left[\vec{a} + \vec{\Omega} \times (\vec{\Omega} \times \vec{r}) + 2\vec{v} \times \vec{\Omega} \right]$$

Relational Mechanics

and Implementation of Mach's Principle
with Weber's Gravitational Force

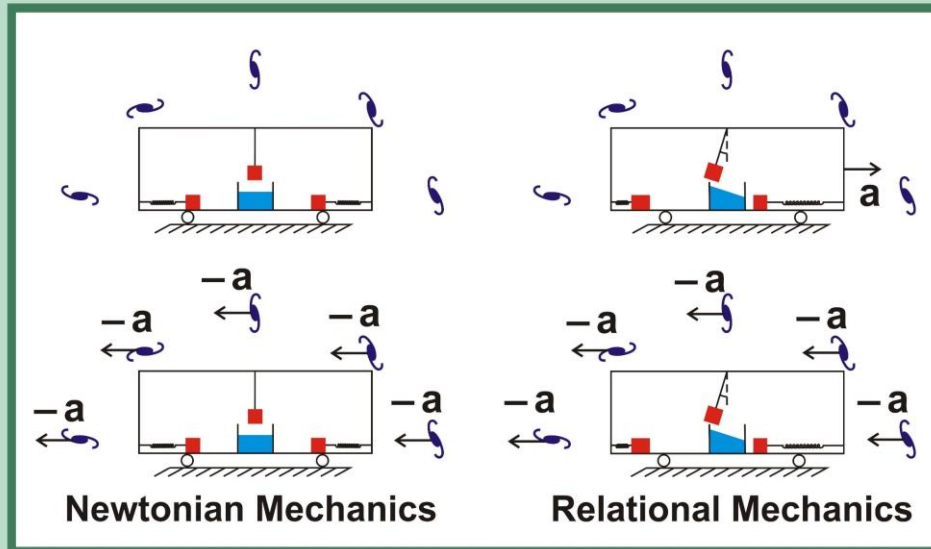

Andre Koch Torres Assis

Available at www.ifi.unicamp.br/~assis

Weber's planetary model of the atom (1870-1880):

$$\frac{q_1 q_2}{4\pi\epsilon_0} \frac{1}{r^2} \left(1 - \frac{\dot{r}^2}{2c^2} + \frac{r \ddot{r}}{c^2} \right) \approx \frac{q_1 q_2}{4\pi\epsilon_0} \frac{1}{r^2} + \frac{q_1 q_2}{4\pi\epsilon_0 r c^2} a = ma$$

$$\frac{q_1 q_2}{4\pi\epsilon_0} \frac{1}{r^2} = \left(m - \frac{q_1 q_2}{4\pi\epsilon_0 r c^2} \right) a$$

$$m = \frac{q_1 q_2}{4\pi\epsilon_0 r c^2}$$

when

$$r = \frac{q_1 q_2}{4\pi\epsilon_0 m c^2} = r_c$$

Weber's planetary model of the atom (1870-1880):

$$\frac{q_1 q_2}{4\pi\epsilon_0} \frac{1}{r^2} \left(1 - \frac{\dot{r}^2}{2c^2} + \frac{r \ddot{r}}{c^2} \right) \approx \frac{q_1 q_2}{4\pi\epsilon_0} \frac{1}{r^2} + \frac{q_1 q_2}{4\pi\epsilon_0 r c^2} a = ma$$

$$\frac{q_1 q_2}{4\pi\epsilon_0} \frac{1}{r^2} = \left(m - \frac{q_1 q_2}{4\pi\epsilon_0 r c^2} \right) a$$

$$m = \frac{q_1 q_2}{4\pi\epsilon_0 r c^2}$$

when

$$r = \frac{q_1 q_2}{4\pi\epsilon_0 m c^2} = r_C$$

Two positrons attract one another
for distances smaller than:

$$r_C = 10^{-15} m$$

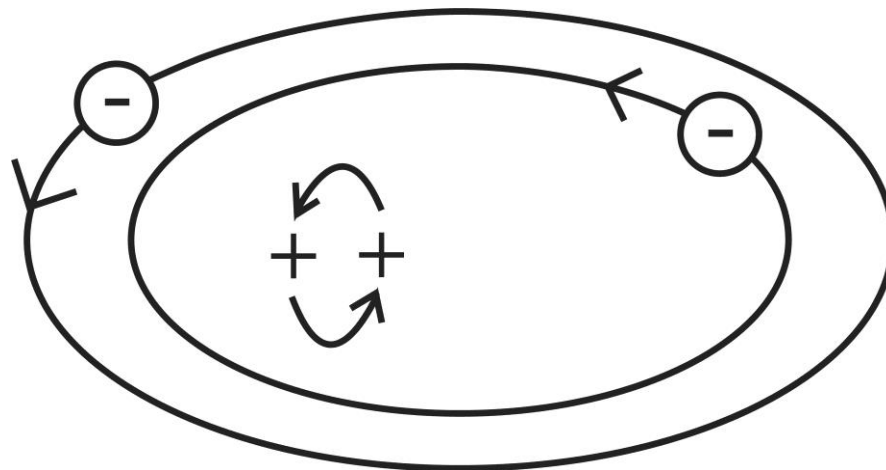

Remarkable properties of Weber's model of the atom:

- Weber's **prediction** (1870-1880) was made before the discovery of the electron (1897), of Balmer's spectral series (1897) and of Rutherford's scattering experiments (1911)! Bohr's model (1913), on the other hand, was **created (invented)** in order to be compatible with these experimental findings.

Remarkable properties of Weber's model of the atom:

- Weber's **prediction** (1870-1880) was made before the discovery of the electron (1897), of Balmer's spectral series (1897) and of Rutherford's scattering experiments (1911)! Bohr's model (1913), on the other hand, was **created (invented)** in order to be compatible with these experimental findings.
- Weber presented a formula for his critical distance r_c below which two charges of the same sign would attract one another. But he could not calculate its value as the electrons and positrons (1932) were unknown. When we utilize the modern values of the mass and charge of two positrons, we obtain that they will attract each other when **$r_c < 10^{-15} \text{ m}$** . Therefore Weber's model gives a **justification** for the known size of the atomic nuclei!

Remarkable properties of Weber's model of the atom:

- Weber's **prediction** (1870-1880) was made before the discovery of the electron (1897), of Balmer's spectral series (1897) and of Rutherford's scattering experiments (1911)! Bohr's model (1913), on the other hand, was **created (invented)** in order to be compatible with these experimental findings.
- Weber presented a formula for his critical distance r_c below which two charges of the same sign would attract one another. But he could not calculate its value as the electrons and positrons (1932) were unknown. When we utilize the modern values of the mass and charge of two positrons, we obtain that they will attract each other when **$r_c < 10^{-15} \text{ m}$** . Therefore Weber's model gives a **justification** for the known size of the atomic nuclei!
- In modern physics it is necessary to **postulate** the existence of nuclear forces in order to stabilize the positively charged nucleus against Coulomb's repulsive forces. Weber's model, on the other hand, offers an **unification** of electromagnetism with nuclear physics, as the nucleus is held together by purely electrodynamic forces!

Nuncius Hamburgensis –
Beiträge zur Geschichte der Naturwissenschaften, Band 19

Andre Koch Torres Assis,
Karl Heinrich Wiederkehr
and Gudrun Wolfschmidt

Weber's Planetary Model of the Atom



 tredition science

2011

Superconductivity with Weber's Electrodynamics

$$\frac{q_1 q_2}{4\pi\epsilon_0} \frac{\hat{r}}{r^2} \left(1 - \frac{\dot{r}^2}{2c^2} + \frac{r \ddot{r}}{c^2} \right) = m \vec{a}$$

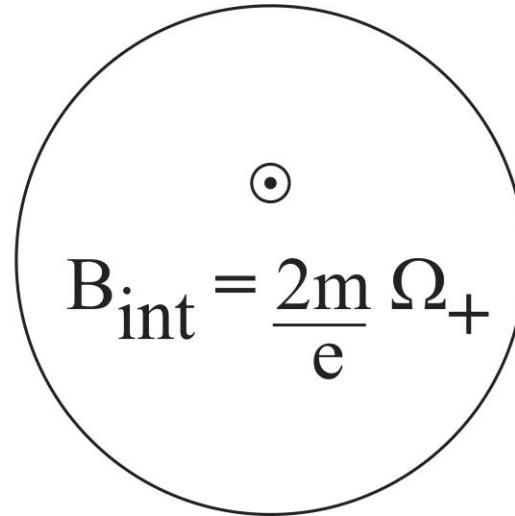
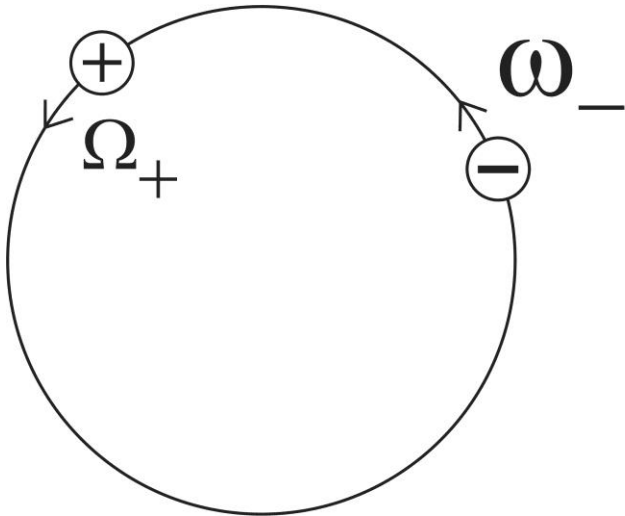

$$B_{\text{ext}} = 0$$

London moment

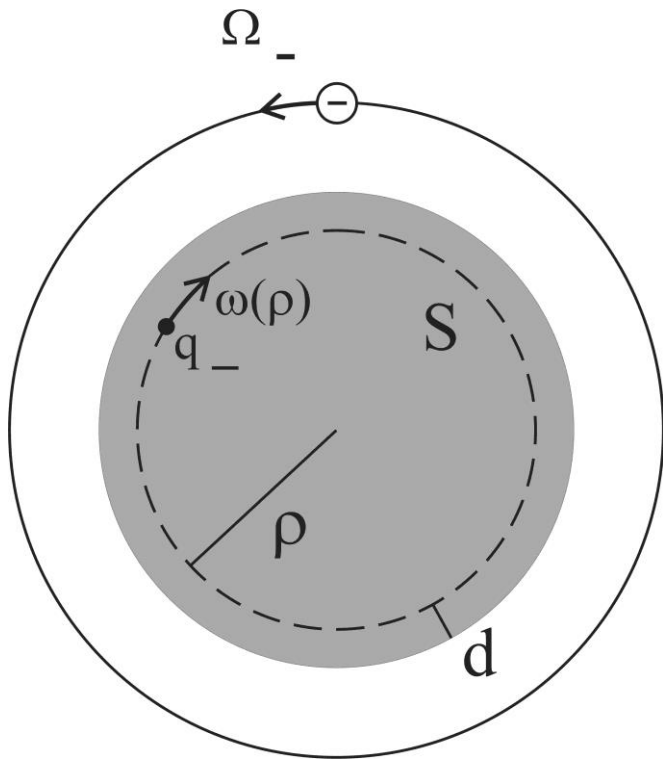

$$\vec{B} = \vec{B}_{apl} e^{-d/\lambda_L}$$

$$\lambda_L = \sqrt{\frac{m}{\mu_0 n e^2}} = \text{London penetration depth}$$

$$\vec{B}_{internal} = \vec{0} \quad (\text{Meissner effect})$$

A. K. T. Assis and M. Tajmar, “Superconductivity with Weber's electrodynamics: the London moment and the Meissner effect”, *Annales de la Fondation Louis de Broglie*, Vol. 42, p. 307 (2017).

K. A. Prytz, “Meissner effect in classical physics”, *Progress in Electromagnetics Research M*, Vol. 64, p. 1 (2018).

**Wilhelm Weber's Main Works on
Electrodynamics Translated into English**

**Volume II: Weber's Fundamental Force
and the Unification of the Laws of Coulomb,
Ampère and Faraday**



Edited by Andre Koch Torres Assis

**Wilhelm Weber's Main Works on
Electrodynamics Translated into English**

**Volume IV: Conservation of Energy,
Weber's Planetary Model of the Atom and the
Unification of Electromagnetism and Gravitation**

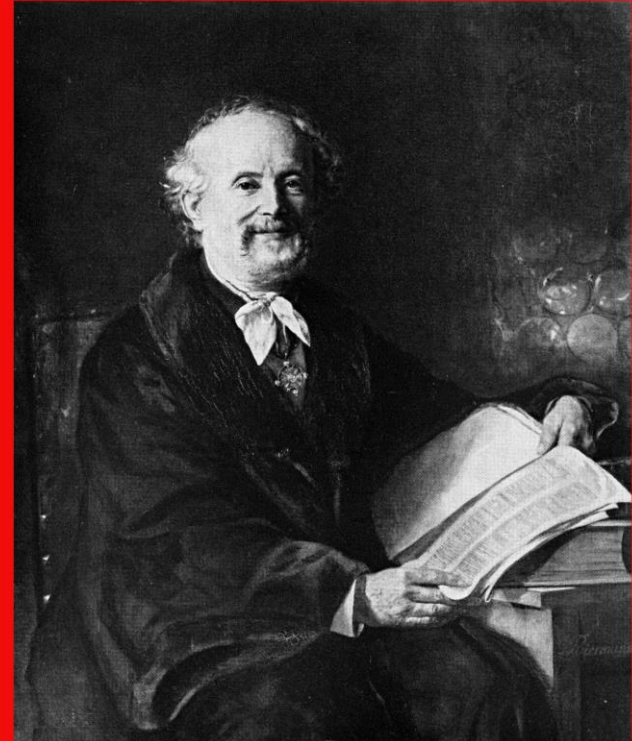

Edited by Andre Koch Torres Assis

4 volumes available at www.ifi.unicamp.br/~assis

Conclusion

Weber's electrodynamics is extremely powerful.

In the last few years there has been a renewed interest in Weber's electrodynamics due to novel experiments and new theoretical developments.

www.ifi.unicamp.br/~assis